

Article number: 435700035

Description: Rota-fix shaft-hub connection K 35x60

Note: Self centering. Medium torque

Measures

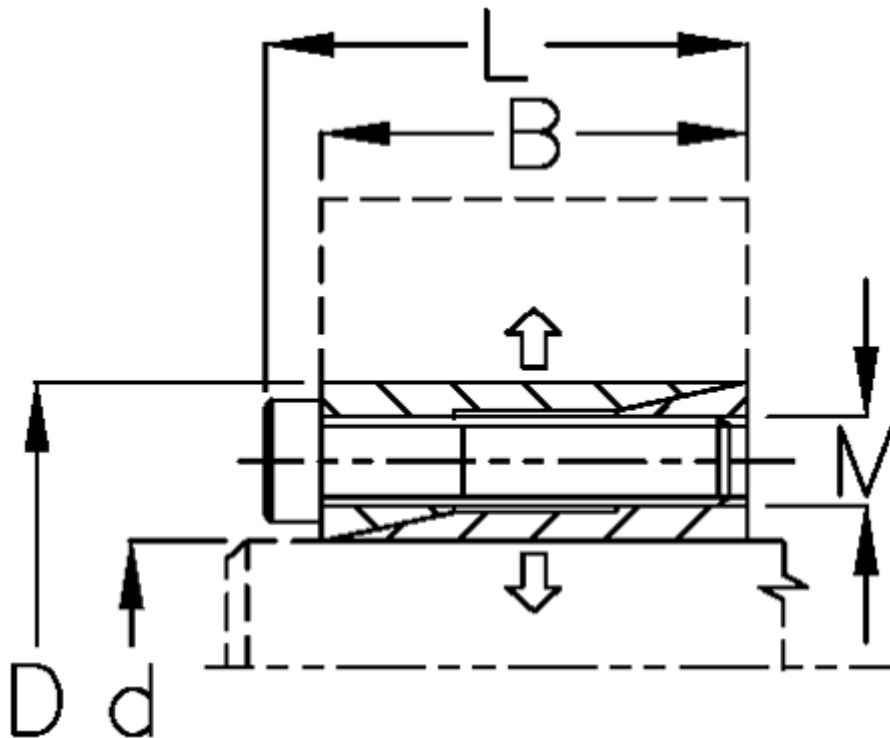

B mm	= 31
d mm	= 35.00
D mm	= 60
Fit tolerance	= Aksel h8, Nav H8
F kN torque	= 40.0
L mm	= 37.0
M mm	= M6
P N/mm ² surface pressure on shaft/hub	= 95

Surface roughness	= R? ? 3.2 µm
T N m torque	= 730
Ts N m bolt tightening torque	= 16.5